

MT

CIESSE



Caratteristiche generali

General features

Il torrino di estrazione MT viene normalmente impiegato per aspirare notevoli volumi d'aria con basse pressioni. Le dimensioni ed il suo peso contenuto facilitano il montaggio direttamente sui tetti, sia ad aspirazione libera che allacciato a canne fumarie. L'esecuzione particolarmente curata nella scelta dei materiali e il meticoloso collaudo lo rendono duraturo nel tempo evitando le costose manutenzioni.

CARATTERISTICHE COSTRUTTIVE

La costruzione in acciaio zincato ed il cupolino in vetroresina garantiscono la perfetta difesa dagli agenti atmosferici.

ACCOPIAMENTO

Il motore elettrico e la ventola, equilibrata staticamente e dinamicamente, garantiscono massima silenziosità. La gamma si articola in 12 modelli equipaggiati con motore trifase; a richiesta si forniscono in esecuzione monofase motori fino alla grandezza 90, accoppiati ad un variatore di giri per una migliore regolazione della portata dell'aria.

A richiesta, si possono montare motori a doppia velocità. Il torrino, in esecuzione speciale a richiesta, può operare in servizio continuo fino alla temperatura di 200° C.

The MT roof-top exhasut fan is used to draw considerable volumes of air at low pressure. The dimensions and low weight facilitate its assembly directly on roofs, both with free aspiration and with connections to flues.

The particularly careful choice of materials and meticulous testing procedure mean the unit is long lasting and needs little maintenance.

TECHNICAL SPECIFICATIONS

The construction in galvanized steel and the small fiberglass-reinforced plastic dome guarantee perfect protection against atmospheric agents.

COUPLING

The electric motor and fan, statically and dynamically balanced, guarantee low operational noise.

The range includes 12 models equipped with 3-phase motors. On request these can be provided with monophase motors up to size 90, coupled with a revolution variator for better adjustment of air delivery. On request, it is possible to assemble double speed motors. The roof-top exhaust fan, on request and in its special configuration, can operate in continuous service up to a temperature of 200° C.

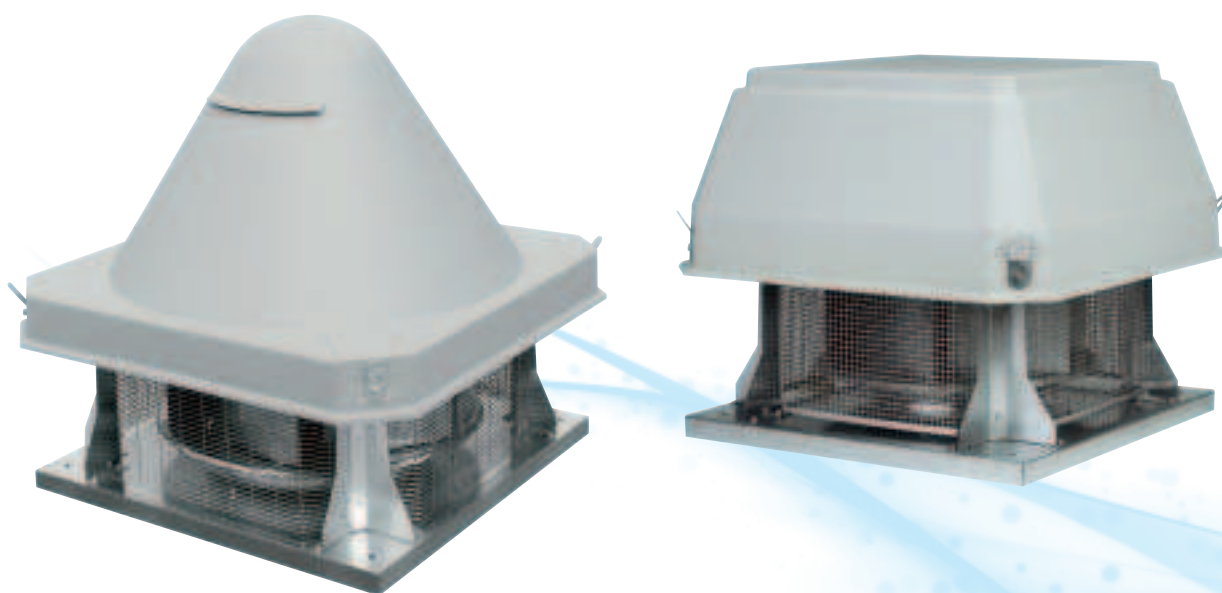

MT

Dimensioni d'ingombro Overall dimensions

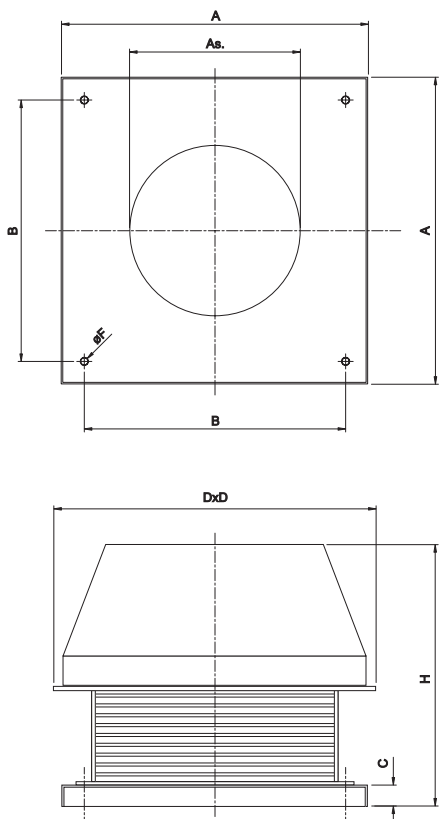

114

MODELLO TYPE	Peso Kg Weight Kg	A	B	D	As.	H	C	ϕF
MT 100	14	400	350	470	200	460	40	11,2
MT 200	18	400	350	470	250	460	40	11,2
MT 300	25	560	460	595	300	560	40	11,2
MT 400	30	560	460	595	350	560	40	11,2
MT 500	40	710	610	800	400	620	40	11,2
MT 600	48	710	610	800	450	620	40	11,2
MT 700	57	900	800	1000	500	790	40	11,2
MT 800	76	900	800	1000	550	830	45	11,2
MT 900	96	900	800	1000	600	870	45	11,2
MT 1000	110	900	800	1000	600	880	45	11,2
MT 1100	170	1200	1100	1250	640	1120	50	11,2
MT 1200	195	1200	1100	1250	710	1160	50	11,2

MT Caratteristiche Features

MODELLO TYPE	Potenza kW Power kW	Giri Min RPM	Livello sonoro dB(A) Noise level dB(A)
MT 104	0,12	1400	45
MT 106	0,09	900	36
MT 204	0,18	1400	52
MT 206	0,09	900	46
MT 304	0,25	1400	56
MT 306	0,18	900	48
MT 404	0,37	1400	61
MT 406	0,18	900	50
MT 504	0,75	1400	63
MT 506	0,37	900	52
MT 604	1,1	1400	65
MT 606	0,37	900	56
MT 608	0,18	700	48
MT 706	0,75	900	60
MT 708	0,37	700	52
MT 806	1,1	900	63
MT 808	0,55	700	54
MT 906	2,2	900	66
MT 908	1,1	700	57
MT 1006	3	900	76
MT 1008	2,2	700	66
MT 1106	4	900	73
MT 1108	3	700	65
MT 1206	7,5	900	75
MT 1208	4	700	67

Prestazioni - Performances

MOD. TYPE	Portata Flowrate	PRESSIONE IN mmH ₂ O - PRESSURE IN mmH ₂ O																			
		1	5	7	10	13	15	18	20	24	25	27	28	30	32	35	40	42	45	50	60
MT 104	m3/h	1500	1400	1300	1200	1100	1050	900	800												
MT 106	m3/h	1000	750	550																	
MT 204	m3/h	2300	2000	1900	1800	1650	1550	1450	1350	1100											
MT 206	m3/h	1500	1150	900	700																
MT 304	m3/h	3100	3100	3000	2800	2700	2600	2500	2400	2300	2200	2100	2000	1900	1700						
MT 306	m3/h	2200	1800	1500	1350	1050															
MT 404	m3/h	5000	4600	4500	4300	4100	4000	3800	3700	3500	3400	3300	3200	3100	3000	2800	2500	2300			
MT 406	m3/h	3200	2700	2500	2200	2000	1750	1500													
MT 504	m3/h	7500	7000	6800	6500	6200	6000	5700	5500	5400	5300	5200	5100	4900	4700	4500	4300	4200	4000	3800	3000
MT 506	m3/h	4600	4000	3700	3400	3100	2800	2500	2300	2100	2000										
MT 604	m3/h	11000	10000	9700	9500	9000	8500	8200	8000	7900	7800	7700	7600	7500	7250	7000	6500	6400	6300	6000	5000
MT 606	m3/h	6800	6000	5700	5300	4800	4500	4200	4000	3600	3300	3000									
MT 608	m3/h	4800	4000	3500	3000	2500	2100														
MT 706	m3/h	9800	9000	8400	8000	7400	7000	6600	6200	5800	5600	5400	5200	4600	4000						
MT 708	m3/h	6500	5500	5000	4500	4000	3700	3300	2900												
MT 806	m3/h	14000	13000	12000	11500	11000	10500	10000	9500	9000	8700	8500	8300	8000	7500	7000	6500	6300	6000	5500	
MT 808	m3/h	9500	8000	7000	6500	6000	5500	5200	5000	4600	4200	3800	3400								
MT 906	m3/h	19500	18000	17500	16500	16000	15000	14500	14000	13700	13300	13100	12900	12500	12200	12000	11000	10500	10000	9500	8000
MT 908	m3/h	13500	11000	10000	9500	9000	8500	8000	7500	7100	6900	6600	6300	6000	5500	5000					
MT 1006	m3/h	20000	19500	19300	19000	18600	18400	18000	17200	16000	15600	15400	15000	14500	14000	12900	11600	10900	10000	8600	5200
MT 1008	m3/h	16000	14000	13400	12900	12000	11000	10500	10000	9000	8600	8000	7200	6900	6000	4000					
MT 1106	m3/h	24000	23800	23500	23000	22800	22500	22200	22000	21500	21000	20600	20500	20200	20000	19500	17500	17000	16400	14900	11500
MT 1108	m3/h	19500	18000	17000	16500	16000	15000	14000	13500	12000	11800	11000	10600	10000	9200	8000	6000				
MT 1206	m3/h	30000	29500	29300	29000	28800	28500	28300	28100	27900	27600	27400	27300	27100	26900	25500	24700	24000	23000	22000	18500
MT 1208	m3/h	28000	27000	26200	25800	25000	24800	24000	22500	21000	20500	19800	19000	18500	18000	16500	13800	12000	10000		

P (mm H₂O)

— Pt= Pressione totale(4 poli) - Total pressure (4 poles) — Pt= Pressione totale (6 poli) - Total pressure (6 poles) — Pt= Pressione totale (8 poli) - Total pressure (8 poles)

mod. MT 104-106

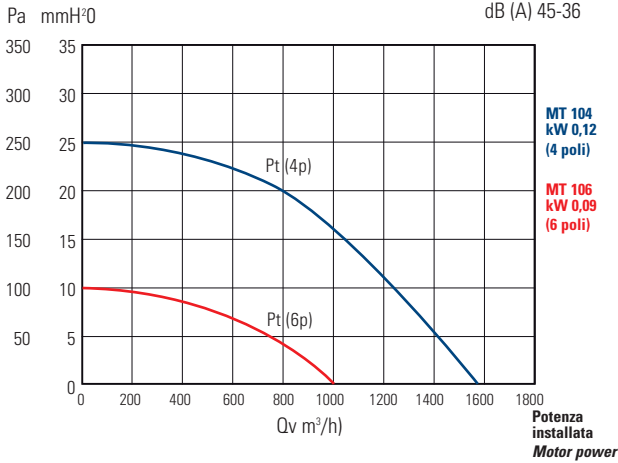

mod. MT 204-206

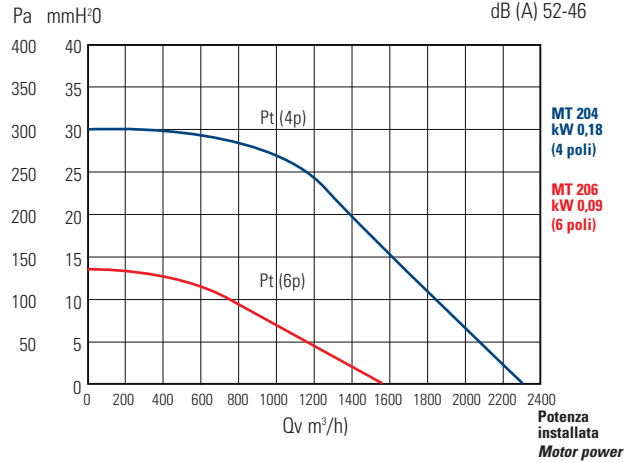

mod. MT 304-306

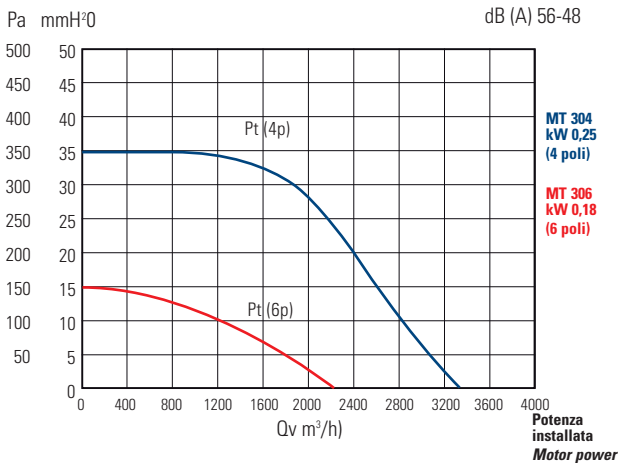

mod. MT 404-406

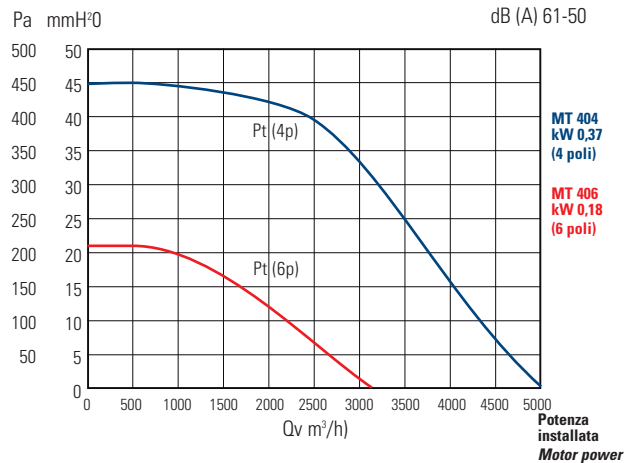

mod. MT 504-506

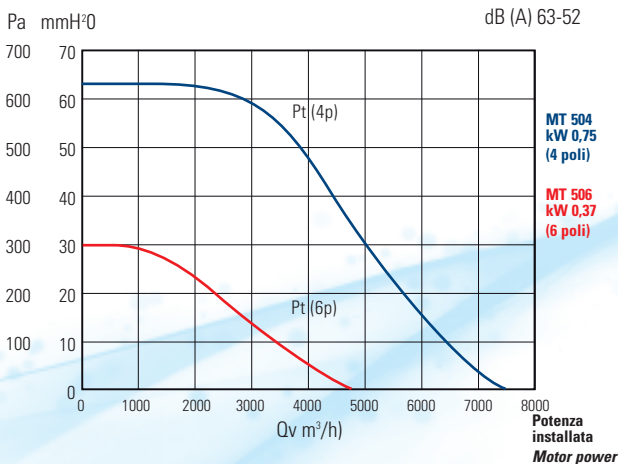

mod. MT 604-606-608

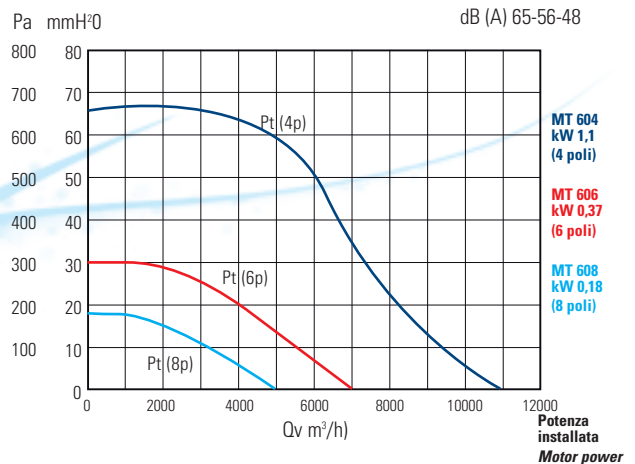

Prestazioni Performances

MT

— Pt= Pressione totale(4 poli) - Total pressure (4 poles) — Pt= Pressione totale (6 poli) - Total pressure (6 poles) — Pt= Pressione totale (8 poli) - Total pressure (8 poles)

mod. MT 706-708

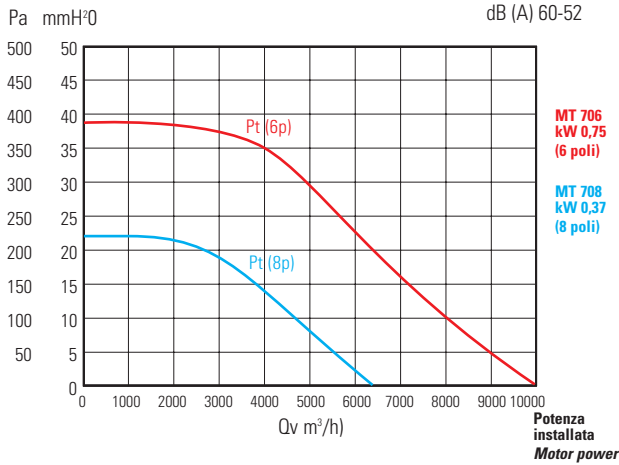

mod. MT 806-808

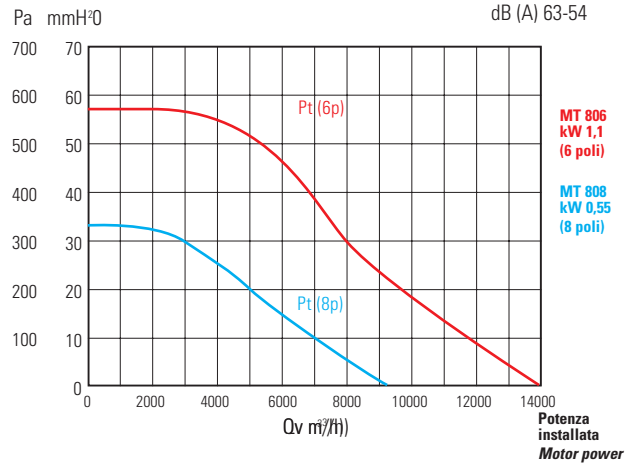

mod. MT 906-908

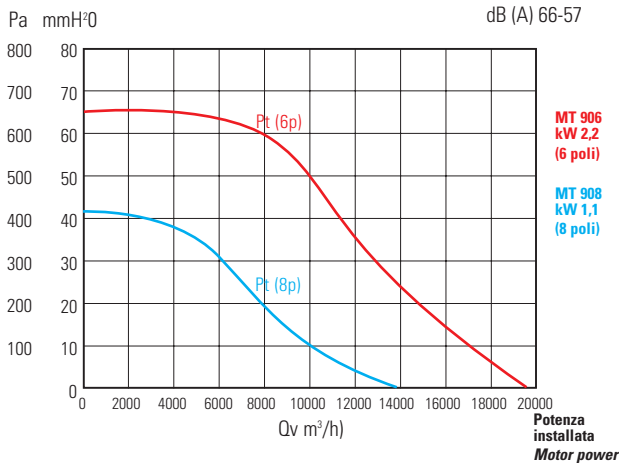

mod. MT 1006-1008

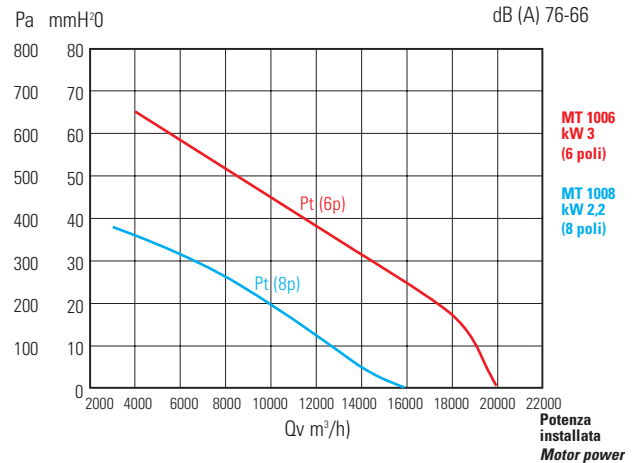

mod. MT 1106-1108

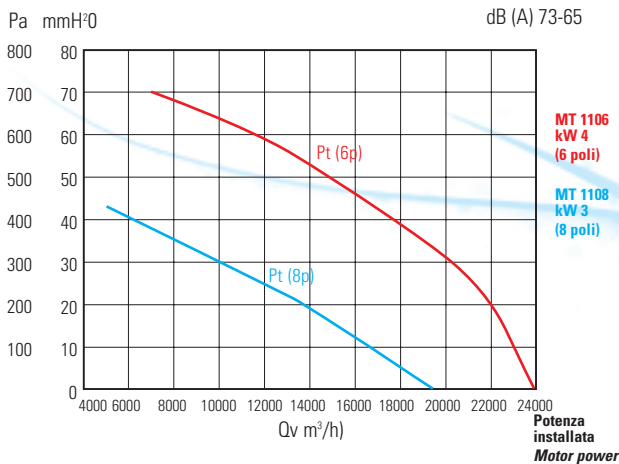

mod. MT 1206-1208

